

**GB** Operator's manual 2-21

**SE** Bruksanvisning 22-41

**DK** Brugsanvisning 42-61

**NO** Bruksanvisning 62-81

**FI** Käyttöohje 82-101

**DE** Bedienungsanweisung 102-121

**FR** Manuel d'utilisation 122-141

**NL** Gebruiksaanwijzing 142-161

**ES** Manual de instrucciones 162-181

**PT** Instruções para o uso 182-201

**IT** Istruzioni per l'uso 202-221-197

**EE** Käsitsemisõpetus 222-241

**LV** Lietošanas pamācība 242-261

**LT** Naudojimosi instrukcijos 262-281

**CZ** Návod k použití 282-301

**SK** Návod na obsluhu 302-321

**HU** Használati utasítás 322-341

**PL** Instrukcja obsługi 342-361

**HR** Priručnik 362-381

**RU** Руководство по  
эксплуатации 382-402

**BG** Ръководство за  
експлоатация 403-423

**RO** Instrucțiuni de utilizare 424-443

**GR** Οδηγίες χρήσεως 444-464



**SUPERLITE 4528**  
**ERGOLITE 6028**



# KEY TO SYMBOLS

## Symbols

**WARNING!** Incorrect or careless use of a hedge trimmer can turn it into a dangerous tool that can cause serious or even fatal injury. It is extremely important that you read and understand the contents of this operator's manual.



Please read the operator's manual carefully and make sure you understand the instructions before using the machine.



Always wear:

- Approved hearing protection
- Approved eye protection



This product is in accordance with applicable EC directives.



Always wear approved protective gloves.



Wear sturdy, non-slip boots or shoes.



Noise emission to the environment according to the European Community's Directive. The machine's emission is specified in chapter Technical data and on label.



**Ignition; choke:** Set the choke control in the choke position.



Air purge.



Starting instructions See the instructions under the heading Start and stop.



**Other symbols/decals on the machine refer to special certification requirements for certain markets.**

The engine is switched off by moving the stop switch to the stop position. **CAUTION!** The stop switch automatically returns to the start position. In order to prevent unintentional starting, the spark plug cap must be removed from the spark plug when assembling, checking and/or performing maintenance.

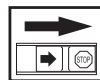

Always wear approved protective gloves.

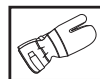

Regular cleaning is required.

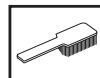

Visual check.



Protective goggles or a visor must be worn.



# CONTENTS

## Contents

### KEY TO SYMBOLS

Symbols ..... 2

### CONTENTS

Contents ..... 3

Note the following before starting: ..... 3

### INTRODUCTION

Dear Customer, ..... 4

### WHAT IS WHAT?

What is what? ..... 5

### GENERAL SAFETY PRECAUTIONS

Important ..... 6

Personal protective equipment ..... 6

Machine's safety equipment ..... 7

### FUEL HANDLING

Fuel safety ..... 10

Fuel ..... 10

Fueling ..... 11

### STARTING AND STOPPING

Check before starting ..... 12

Starting and stopping ..... 12

### WORKING TECHNIQUES

General working instructions ..... 14

### MAINTENANCE

Carburettor ..... 16

Muffler ..... 16

Cooling system ..... 16

Spark plug ..... 16

Air filter ..... 17

Gear ..... 17

Cutting unit ..... 17

Cleaning and lubrication ..... 18

Maintenance schedule ..... 19

### TECHNICAL DATA

Technical data ..... 20

EC-declaration of conformity ..... 21

## Note the following before starting:

Please read the operator's manual carefully.



**WARNING!** Long-term exposure to noise can result in permanent hearing impairment. So always use approved hearing protection.



**WARNING!** Under no circumstances may the design of the machine be modified without the permission of the manufacturer. Always use genuine accessories. Non-authorized modifications and/or accessories can result in serious personal injury or the death of the operator or others.



**WARNING!** Incorrect or careless use of a hedge trimmer can turn it into a dangerous tool that can cause serious or even fatal injury. It is extremely important that you read and understand the contents of this operator's manual.

---

# INTRODUCTION

---

## Dear Customer,

Thank you for choosing a McCulloch product. You are thereby part of a story that started long ago, when the McCulloch Corporation started its manufacturing of engines during World War II. In 1949, when McCulloch introduced its first light one-man chainsaw, woodworking would never be the same again.

The line of innovative chainsaws would continue over the decades, and business was expanded, first by airplane and kart engines in the 1950s, then by mini chainsaws in the 1960s. Later, in the 1970s and 80s, trimmers and blower vacs were added to the range.

Today, as a part of the Husqvarna group, McCulloch continues the tradition of powerful engines, technical innovations, and strong designs that have been our hallmarks for more than half a century. Lowering fuel consumption, emissions and noise levels are of top priority to us, as is improving safety and user-friendliness.

We certainly hope that you will be satisfied with your McCulloch product, as it is designed to be your companion for a long time. By following this operators manual's advice on usage, service, and maintenance, its lifespan can be extended. If you should need professional help with repair or service, please use the Service Locator at [www.mcculloch.biz](http://www.mcculloch.biz).

McCulloch has a policy of continuous product development and therefore reserves the right to modify the design and appearance of products without prior notice.

This manual can also be downloaded at [www.mcculloch.biz](http://www.mcculloch.biz).

## WHAT IS WHAT?

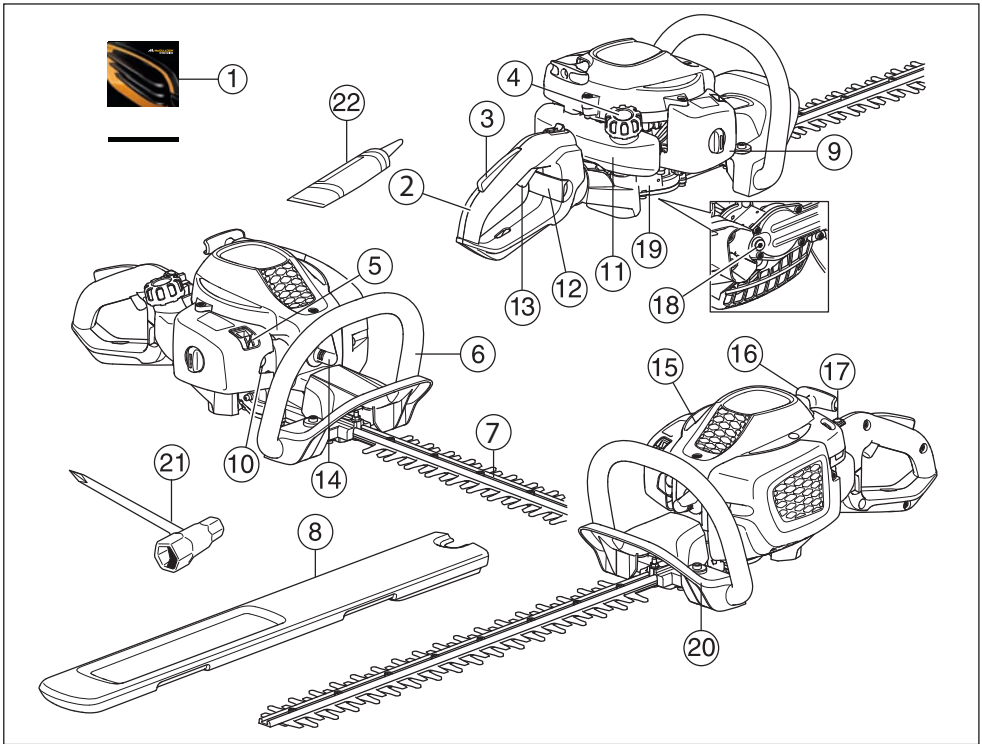

### What is what?

- |                         |                                    |
|-------------------------|------------------------------------|
| 1 Operator's manual     | 12 Lock for handle (ErgoLite 6028) |
| 2 Handle                | 13 Throttle trigger                |
| 3 Throttle lock         | 14 Spark plug cap and spark plug   |
| 4 Fuel cap              | 15 Cylinder cover                  |
| 5 Choke control         | 16 Starter handle                  |
| 6 Front handle          | 17 Stop switch                     |
| 7 Blade and blade guard | 18 Lubricant filler cap, gear      |
| 8 Transport guard       | 19 Gear                            |
| 9 Air filter cover      | 20 Hand guard                      |
| 10 Air purge.           | 21 Combination spanner             |
| 11 Fuel tank            | 22 Tube of grease                  |

# GENERAL SAFETY PRECAUTIONS

## Important

### IMPORTANT!

The machine is only designed for cutting branches and twigs.

Never use a machine that has been modified in any way from its original specification.

Never use the machine if you are tired, if you have drunk alcohol, or if you are taking medication that could affect your vision, your judgement or your co-ordination.

Wear personal protective equipment. See instructions under the heading "Personal protective equipment".

Never use the machine in extreme weather conditions such as severe cold, very hot and/or humid climates.

Never use a machine that is faulty. Carry out the checks, maintenance and service instructions described in this manual. Some maintenance and service measures must be carried out by trained and qualified specialists. See instructions under the heading Maintenance.

All covers and guards must be fitted before starting. Ensure that the spark plug cap and ignition lead are undamaged to avoid the risk of electric shock.



**WARNING! This machine produces an electromagnetic field during operation. This field may under some circumstances interfere with active or passive medical implants. To reduce the risk of serious or fatal injury, we recommend persons with medical implants to consult their physician and the medical implant manufacturer before operating this machine.**



**WARNING! Running an engine in a confined or badly ventilated area can result in death due to asphyxiation or carbon monoxide poisoning.**



**WARNING! Never allow children to use or be in the vicinity of the machine. As the machine is equipped with a spring-loaded stop switch and can be started by low speed and force on the starter handle, even small children under some circumstances can produce the force necessary to start the machine. This can mean a risk of serious personal injury. Therefore remove the spark plug cap when the machine is not under close supervision.**



**WARNING! Faulty blades can increase the risk of accidents.**

## Personal protective equipment

### IMPORTANT!

Incorrect or careless use of a hedge trimmer can turn it into a dangerous tool that can cause serious or even fatal injury. It is extremely important that you read and understand the contents of this operator's manual.

You must use approved personal protective equipment whenever you use the machine. Personal protective equipment cannot eliminate the risk of injury but it will reduce the degree of injury if an accident does happen. Ask your dealer for help in choosing the right equipment.



**WARNING! Listen out for warning signals or shouts when you are wearing hearing protection. Always remove your hearing protection as soon as the engine stops.**

### HEARING PROTECTION

Wear hearing protection that provides adequate noise reduction.



### EYE PROTECTION

Always wear approved eye protection. If you use a visor then you must also wear approved protective goggles. Approved protective goggles must comply with standard ANSI Z87.1 in the USA or EN 166 in EU countries.



### GLOVES

Gloves should be worn when necessary, e.g., when fitting cutting attachments.



### BOOTS

Wear sturdy, non-slip boots or shoes.



# GENERAL SAFETY PRECAUTIONS

## CLOTHING

Wear clothes made of a strong fabric and avoid loose clothing that can catch on twigs and branches. Always wear heavy, long pants. Do not wear jewellery, shorts sandals or go barefoot. Secure hair so it is above shoulder level.

## FIRST AID KIT

Always have a first aid kit nearby.



## Machine's safety equipment

This section describes the machine's safety equipment, its purpose, and how checks and maintenance should be carried out to ensure that it operates correctly. See the "What is what?" section to locate where this equipment is positioned on your machine.

The life span of the machine can be reduced and the risk of accidents can increase if machine maintenance is not carried out correctly and if service and/or repairs are not carried out professionally. If you need further information please contact your nearest service workshop.

### IMPORTANT!

All servicing and repair work on the machine requires special training. This is especially true of the machine's safety equipment. If your machine fails any of the checks described below you must contact your service agent. When you buy any of our products we guarantee the availability of professional repairs and service. If the retailer who sells your machine is not a servicing dealer, ask him for the address of your nearest service agent.



**WARNING! Never use a machine with faulty safety equipment. The machine's safety equipment must be checked and maintained as described in this section. If your machine fails any of these checks contact your service agent to get it repaired.**

## Throttle lockout

The throttle lockout is designed to prevent accidental operation of the throttle control. When you press the lock (A) (i.e. when you grasp the handle) it releases the throttle control (B). When you release the handle the throttle control and the throttle lockout both move back to their original positions. This movement is controlled by two independent return springs. This arrangement means that the throttle control is automatically locked at the idle setting.

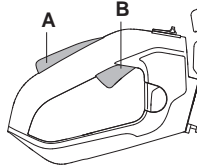

Make sure the throttle control is locked at the idle setting when the throttle lockout is released.

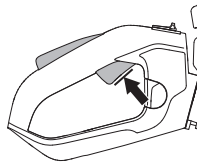

Press the throttle lockout and make sure it returns to its original position when you release it.

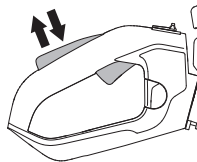

Check that the throttle trigger and throttle lockout move freely and that the return springs work properly.

See instructions under the heading Start. Start the hedge trimmer and apply full throttle. Release the throttle trigger and check that the blades stop and remain stationary. If the blades move when the throttle trigger is in the idle position then the carburettor idle setting must be adjusted. See instructions under the heading Maintenance.

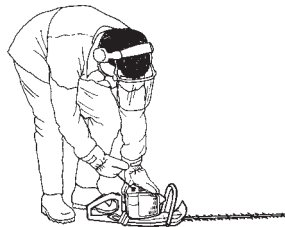

# GENERAL SAFETY PRECAUTIONS

## Stop switch

Use the stop switch to switch off the engine.

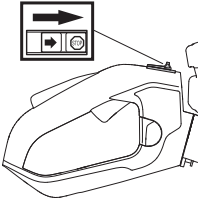

Start the engine and make sure the engine stops when you move the stop switch to the stop setting. The stop switch automatically returns to the start position. In order to prevent unintentional starting, the spark plug cap must be removed from the spark plug when assembling, checking and/or performing maintenance.

## Hand guard



The hand guard prevents hands from coming into contact with the moving blades, for example, if the operator loses grip on the front handle.

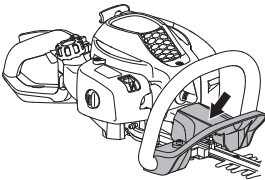

Check that the hand guard is fitted correctly.

Check that the hand guard is undamaged.

## Vibration damping system



Your machine is equipped with a vibration damping system that is designed to minimize vibration and make operation easier.

The machine's vibration damping system reduces the transfer of vibration between the engine unit/cutting equipment and the machine's handle unit.

The engine body, including the blades, is suspended on the handlebar using four rubber bushings.

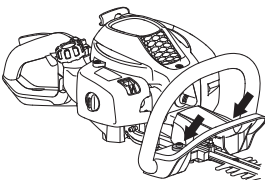

Regularly check the vibration damping units for cracks or deformation. Check that the vibration damping element is undamaged and securely attached.



**WARNING! Overexposure to vibration can lead to circulatory damage or nerve damage in people who have impaired circulation. Contact your doctor if you experience symptoms of overexposure to vibration. Such symptoms include numbness, loss of feeling, tingling, pricking, pain, loss of strength, changes in skin colour or condition. These symptoms normally appear in the fingers, hands or wrists. The risk increases at low temperatures.**

## Muffler

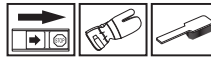

The muffler is designed to keep noise levels to a minimum and to direct exhaust fumes away from the user. A muffler fitted with a catalytic converter is also designed to reduce harmful exhaust gases.



In countries that have a warm and dry climate there is a significant risk of fire. We therefore fit certain mufflers with a spark arrestor mesh. Check whether the muffler on your machine is fitted with this kind of mesh.



For mufflers it is very important that you follow the instructions on checking, maintaining and servicing your machine.

Never use a machine that has a faulty muffler.



Regularly check that the muffler is securely attached to the machine.





# GENERAL SAFETY PRECAUTIONS

If the muffler on your machine is fitted with a spark arrestor mesh this must be cleaned regularly. A blocked mesh will cause the engine to overheat and may lead to serious damage.

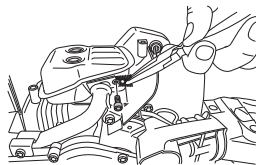

**WARNING!** Mufflers fitted with catalytic converters get very hot during use and remain so for some time after stopping. This also applies at idle speed. Contact can result in burns to the skin. Remember the risk of fire!



**WARNING!** The inside of the muffler contain chemicals that may be carcinogenic. Avoid contact with these elements in the event of a damaged muffler.



**WARNING!** Bear in mind that: The exhaust fumes from the engine are hot and may contain sparks which can start a fire. Never start the machine indoors or near combustible material!

## Blade and blade guard



The outer part of the blades (1) are shaped as blade guards. The blade guard is intended to protect against any part of the body coming into contact with the blades.

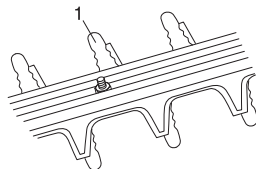

Check that the blade guard is not damaged or distorted. Replace the cutting unit if it is bent or damaged.

## Gear

The gear housing gets hot when the machine has been in use. To avoid burning yourself do not touch the gear housing.

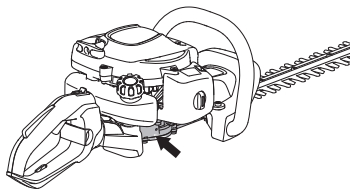

# FUEL HANDLING

## Fuel safety

Never start the machine:

- 1 If you have spilt fuel on it. Wipe off the spillage and allow remaining fuel to evaporate.
- 2 If you have spilt fuel on yourself or your clothes, change your clothes. Wash any part of your body that has come in contact with fuel. Use soap and water.
- 3 If the machine is leaking fuel. Check regularly for leaks from the fuel cap and fuel lines.

## Transport and storage

- Allow the hedge trimmer to cool down after use before putting it away for storage.
- Store and transport the machine and fuel so that there is no risk of any leakage or fumes coming into contact with sparks or naked flames, for example, from electrical machinery, electric motors, electrical relays/switches or boilers.
- When storing and transporting fuel always use approved containers intended for this purpose.
- When storing the machine for long periods the fuel tank must be emptied. Contact your local petrol station to find out where to dispose of excess fuel.
- Ensure the machine is cleaned and that a complete service is carried out before long-term storage.
- The transport guard must always be fitted to the cutting attachment when the machine is being transported or in storage.
- Secure the machine during transport.



**WARNING! Take care when handling fuel. Bear in mind the risk of fire, explosion and inhaling fumes.**

## Fuel

**CAUTION!** The machine is equipped with a two-stroke engine and must always be run using a mixture of petrol and two-stroke oil. It is important to accurately measure the amount of oil to be mixed to ensure that the correct mixture is obtained. When mixing small amounts of fuel, even small inaccuracies can drastically affect the ratio of the mixture.



**WARNING! Fuel and fuel fumes are highly inflammable and can cause serious injury when inhaled or allowed to come in contact with the skin. For this reason observe caution when handling fuel and make sure there is adequate ventilation.**

## Petrol



**CAUTION!** Always use a quality petrol/oil mixture at least 90 octane (RON). If your machine is equipped with a catalytic converter (see chapter on Technical data) always use a good quality unleaded petrol/oil mixture. Leaded petrol will destroy the catalytic converter.

Use low-emission petrol, also known as alkylate petrol, if it is available.



- The lowest octane recommended is 90 (RON). If you run the engine on a lower octane grade than 90 so-called knocking can occur. This gives rise to a high engine temperature, which can result in serious engine damage.
- When working at continuous high revs a higher octane rating is recommended.

## Two-stroke oil

- For best results and performance use Universal, Universal powered by McCULLOCH two-stroke engine oil, which is specially formulated for our air-cooled two-stroke engines.
- Never use two-stroke oil intended for water-cooled engines, sometimes referred to as outboard oil (rated TCW).
- Never use oil intended for four-stroke engines.
- A poor oil quality and/or too high oil/fuel ratio may jeopardise function and decrease the life time of catalytic converters.
- Mixing ratio

1:50 (2%) with Universal, Universal powered by McCULLOCH two-stroke oil.

1:33 (3%) with oils class JASO FB or ISO EGB formulated for air-cooled, two-stroke engines.

Petrol, litre	Two-stroke oil, litre	
	2% (1:50)	3% (1:33)
5	0,10	0,15
10	0,20	0,30
15	0,30	0,45
20	0,40	0,60

# FUEL HANDLING

## Mixing

- Always mix the petrol and oil in a clean container intended for fuel.
- Always start by filling half the amount of the petrol to be used. Then add the entire amount of oil. Mix (shake) the fuel mixture. Add the remaining amount of petrol.
- Mix (shake) the fuel mixture thoroughly before filling the machine's fuel tank.

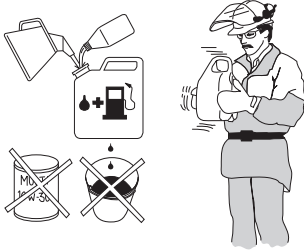

- Do not mix more than one month's supply of fuel at a time.
- If the machine is not used for some time the fuel tank should be emptied and cleaned.



**WARNING!** The catalytic converter muffler gets very hot during and after use. This also applies during idling. Be aware of the fire hazard, especially when working near flammable substances and/ or vapours.

## Fueling



**WARNING!** Taking the following precautions, will lessen the risk of fire:

**Do not smoke or place hot objects near fuel.**

**Always shut off the engine before refuelling.**

**Refuel in a well ventilated area. Never fuel the machine indoors.**

**Always stop the engine and let it cool for a few minutes before refuelling.**

**When refuelling, open the fuel cap slowly so that any excess pressure is released gently.**

**Tighten the fuel cap carefully after refuelling.**

**Always move the machine away from the refuelling area and source before starting.**

- Always use a fuel container with an anti-spill valve.
- Clean the area around the fuel cap. Contamination in the tank can cause operating problems.
- Ensure that the fuel is well mixed by shaking the container before filling the tank.

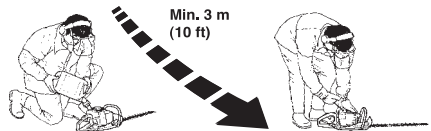

# STARTING AND STOPPING

## Check before starting



- Inspect the working area. Remove any objects that could be thrown out.
- Check the cutting attachment. Never use blades that are dull, cracked or damaged.
- Check that the machine is in perfect working order. Check that all nuts and screws are tight.
- Make sure the gear housing is lubricated correctly. See instructions under the heading Gear housing.
- Check that the cutting attachment always stops when the engine is idling.
- Only use the machine for the purpose it was intended for.
- Make sure that the handle and safety features are in good working order. Never use a machine that lacks a part or has been modified outside its specifications.
- All covers must be correctly fitted and undamaged before you start the machine.

## Starting and stopping



**WARNING! The complete gear housing must be fitted before the machine is started, otherwise the clutch may loosen and cause personal injury.**

**Always move the machine about 3 metres from the refuelling position before starting. Place the machine on a firm surface. Remember that the blades may start to move when the engine is started. Make sure the blades cannot come into contact with any object. Make sure that no unauthorised persons are in the working area, otherwise there is a risk of serious personal injury. The safety distance is 15 metres.**

## Cold engine

### (1) Choke control



Set the choke control in the choke position.

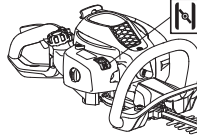

### (2) Primer bulb:



Press the air purge diaphragm repeatedly until fuel begins to fill the diaphragm (about 6 times). The diaphragm need not be completely filled.

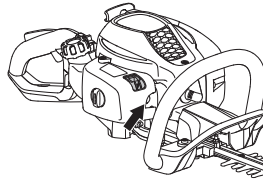

### (3) Starting



Hold the body of the machine on the ground using your left hand (CAUTION! Not with your foot!). Grip the starter handle, slowly pull out the cord with your right hand until you feel some resistance (the starter pawls grip), now quickly and powerfully pull the cord. **Never twist the starter cord around your hand.**



# STARTING AND STOPPING

(4, 5)



Push the choke control back to its original position as soon as the engine fires, and continue trying to start until the engine starts.

**CAUTION!** When the choke control is pushed back to its original position, the engine runs at a heightened speed, the so called start throttle position, and the blades then move. Start throttle position is released by throttling using the throttle lever.

**CAUTION!** Do not pull the starter cord all the way out and do not let go of the starter handle when the cord is fully extended. This can damage the machine.

## Warm engine



Hold the body of the machine on the ground using your left hand (**CAUTION!** Not with your foot!). Grip the starter handle, slowly pull out the cord with your right hand until you feel some resistance (the starter pawls grip), now quickly and powerfully pull the cord. **Never twist the starter cord around your hand.**

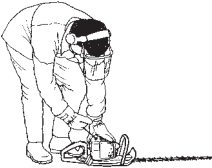

## Stopping

The engine is switched off by moving the stop switch to the stop position.

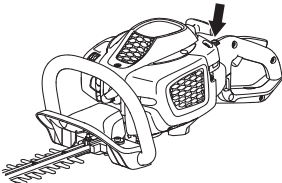

### **CAUTION!**

The stop switch automatically returns to the start position. In order to prevent unintentional starting, the spark plug cap must be removed from the spark plug when assembling, checking and/or performing maintenance.

# WORKING TECHNIQUES

## General working instructions

### IMPORTANT!

This section takes up the basic safety precautions for working with a hedge trimmer.

If you encounter a situation where you are uncertain how to proceed you should ask an expert. Contact your dealer or your service workshop.

Avoid all usage which you consider to be beyond your capability.



**WARNING! The machine can cause serious personal injury. Read the safety instructions carefully. Learn how to use the machine.**



**WARNING! Cutting tool. Do not touch the tool without first switching off the engine.**

## Safety instructions regarding the surroundings

- Never allow children to use the machine.
- Observe your surroundings and make sure that there is no risk of people or animals coming into contact with the cutting equipment.
- Ensure that no-one comes closer than 15 m while you are working.
- Never allow anyone else to use the machine without first ensuring that they have understood the contents of the operator's manual.
- Never work from a ladder, stool or any other raised position that is not fully secured.

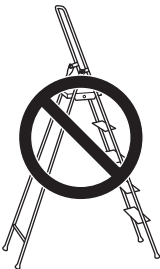

- Keep in mind that the operator is responsible for accidents or hazards occurring to other people or their property.

## Safety instructions while working



- Always ensure you have a safe and stable working position.
- Never leave the machine unsupervised with the motor running.
- Always use both hands to hold the machine. Hold the machine in front of your body.

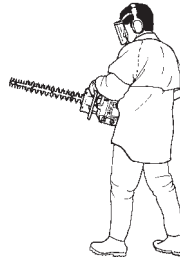

- Make sure that your hands and feet do not come near the cutting attachment when the engine is running.



- When the engine is switched off, keep your hands and feet away from the cutting attachment until it has stopped completely.
- Watch out for stumps of branches that can be thrown out during cutting.
- Do not cut too close to the ground. Stones and other objects can be thrown out.
- Check the working area for foreign objects such as electricity cables, insects and animals, etc, or other objects that could damage the cutting attachment, such as metal items.
- If any foreign object is hit or if vibrations occur stop the machine immediately. Disconnect the HT lead from the spark plug. Check that the machine is not damaged. Repair any damage.

## WORKING TECHNIQUES

- If anything jams in the blades while you are working, switch off the engine and wait until it has stopped completely before cleaning the blades. Disconnect the HT lead from the spark plug.

If the blades get stuck, they can be loosened by sticking the combination spanner into the gear housing. Remove the lubricant plug and stick the combination spanner into the gearing and turn it back and forth.

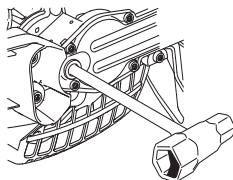

### Safety instructions after completing work



- The transport guard should always be fitted to the cutting attachment when the machine is not in use.
- Make sure the cutting attachment has stopped before cleaning, carrying out repairs or an inspection. Disconnect the HT lead from the spark plug.
- Always wear heavy-duty gloves when repairing the cutting attachment. This is extremely sharp and can easily cause cuts.



- Store the machine out of reach of children.
- Use only original spare parts for repairs.

### Basic working techniques

- Work with a swinging action from the bottom upwards when trimming sides.
- Adjust the throttle setting to suit the load.
- When trimming a hedge the engine should always face away from the hedge.

- Hold the machine as close to your body as possible to get the best balance.

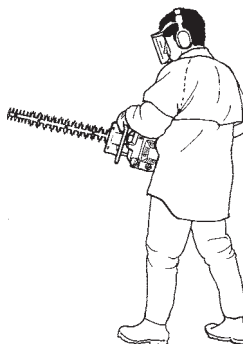

- Make sure that the tip does not touch the ground.
- Do not rush the work, but work steadily until all the branches have been cut back cleanly.

### ERGOLITE 6028

The hedge trimmer's rear handle can be set in five positions by pulling out the catch. See figure. When the handle is adjusted, the hedge trimmer must be idling or not running.

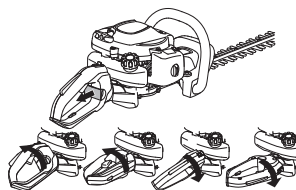

- While working the handle should always be facing upwards irrespective of how the hedge trimmer is directed.

# MAINTENANCE

## Carburettor

### Adjustment of the idle speed

Before any adjustments are made, make sure that the air filter is clean and the air filter cover is fitted. Make sure the start throttle position is disengaged.

Adjust the idle speed using the idle adjustment screw T, if it is necessary to readjust. First turn the T screw clockwise until the cutting attachment starts to move. Then turn the screw anticlockwise until the cutting attachment stops. The idle speed is correctly adjusted when the engine runs smoothly in every position. The idle speed should also be well below the speed at which the cutting attachment starts to move.

**Rec. idle speed:** See the Technical data section.

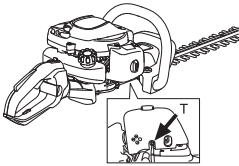

**WARNING!** If the idle speed cannot be adjusted so that the cutting attachment stops, contact your dealer/service workshop. Do not use the machine until it has been correctly adjusted or repaired.

## Muffler



**CAUTION!** Some mufflers are fitted with a catalytic converter. See chapter on Technical data to see whether your machine is fitted with a catalytic converter.

The muffler is designed to reduce the noise level and to direct the exhaust gases away from the operator. The exhaust gases are hot and can contain sparks, which may cause fire if directed against dry and combustible material.

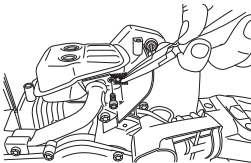

Some mufflers are equipped with a special spark arrestor mesh. If your machine has this type of muffler, the mesh must be cleaned. This is best done with a wire brush.

On mufflers without a catalytic converter, the mesh should be cleaned or replaced if necessary once a week. **If the mesh is damaged it must be replaced.** If the mesh is frequently blocked, this can be a sign that the carburettor

is incorrectly adjusted or that too much oil has been mixed with the petrol.

On mufflers fitted with a catalytic converter, the mesh must be checked, and if necessary cleaned, monthly. **If the mesh is damaged it must be replaced.** If the mesh is frequently blocked, this can be a sign that the performance of the catalytic converter is impaired. Contact your dealer to inspect the muffler. A blocked mesh will cause the machine to overheat and result in damage to the cylinder and piston.

**CAUTION!** Never use a machine with a defective muffler.



**WARNING!** Mufflers fitted with catalytic converters get very hot during use and remain so for some time after stopping. This also applies at idle speed. Contact can result in burns to the skin. Remember the risk of fire!

## Cooling system

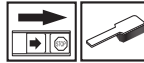

To keep the working temperature as low as possible the machine is equipped with a cooling system.

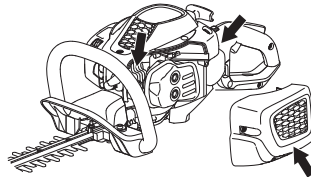

The cooling system consists of:

- 1 Cooling fins on the cylinder.
- 2 Cylinder cover (directs cold air over the cylinder).
- 3 Air intake through the crankcase (inside the tank).

Clean the cooling system with a brush once a week, more often in demanding conditions. A dirty or blocked cooling system results in the machine overheating which causes damage to the piston and cylinder.

## Spark plug



The spark plug condition is influenced by:

- Incorrect carburettor adjustment.
- An incorrect fuel mixture (too much or incorrect type of oil).
- A dirty air filter.

These factors cause deposits on the spark plug electrodes, which may result in operating problems and starting difficulties.



# MAINTENANCE

If the machine is low on power, difficult to start or runs poorly at idle speed: always check the spark plug first before taking any further action. If the spark plug is dirty, clean it and check that the electrode gap is 0,5 mm. The spark plug should be replaced after about a month in operation or earlier if necessary.

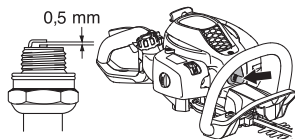

**CAUTION!** Always use the recommended spark plug type! Use of the wrong spark plug can damage the piston/cylinder. Check that the spark plug is fitted with a suppressor.

## Air filter



The air filter must be regularly cleaned to remove dust and dirt in order to avoid:

- Carburettor malfunctions
- Starting problems
- Loss of engine power
- Unnecessary wear to engine parts.
- Excessive fuel consumption.

Clean the filter every 25 hours, or more regularly if conditions are exceptionally dusty.

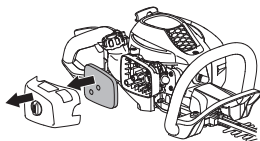

## Cleaning the air filter

Remove the air filter cover and take out the filter. Wash it clean in warm, soapy water. Allow the filter to dry and then oil it in according to the instructions.

An air filter that has been in use for a long time cannot be cleaned completely. The filter must therefore be replaced with a new one at regular intervals. **A damaged air filter must always be replaced.**

## Oiling the air filter

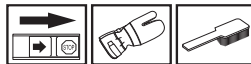

Always use filter oil, art. no. 531 00 92-48. The filter oil contains a solvent to make it spread evenly through the filter. You should therefore avoid skin contact.

Put the filter in a plastic bag and pour the filter oil over it. Knead the plastic bag to distribute the oil. Squeeze the excess oil out of the filter inside the plastic bag and pour off the excess before fitting the filter to the machine. Never use common engine oil. This would drain through the filter quite quickly and collect in the bottom.



## Gear



There is a plug for filling lubricant on the gear housing. Use the grease tube to fill with grease and repeat every 25 hours. Use Husqvarna's special grease.

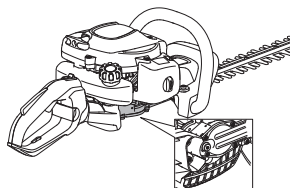

**CAUTION!** The gear housing must not be filled completely with grease. The grease expands as the machine heats up during operation. If the gear housing was completely filled with grease it could damage the seals and lead to leakage of grease.

The grease in the bevel gear does not normally need to be changed except if repairs are carried out.

## Cutting unit

Check that the cutting units' screws are fitted correctly. Tighten them with a tightening torque of 7-10 Nm.

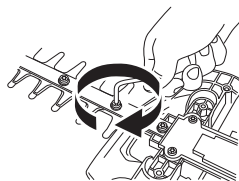

# MAINTENANCE

## Cleaning and lubrication



Clean any resin and plant residue from the blades using cleaning agent 531 00 75-13 (UL22) before and after using the machine.

Check that the blade edges are not damaged or deformed. File away any burrs.

Check that the blades move freely. Remove the lubrication plug in the gear housing and stick in the combination spanner and turn back and forth.

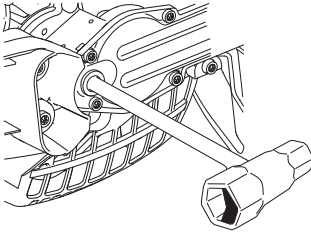

Lubricate the blade bars with special grease, part no. 531 00 75-12 (UL 21) before long periods of storage.

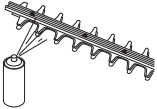

# MAINTENANCE

## Maintenance schedule

The following is a list of the maintenance that must be performed on the machine. Most of the items are described in the Maintenance section. The user must only carry out the maintenance and service work described in this Operator's Manual. More extensive work must be carried out by an authorized service workshop.

Maintenance	Before use:	After 40 hours in use	After 100 hours in use
Clean the outside of the machine.	After each time the machine is used		
Make sure the throttle trigger lock and the throttle function correctly from a safety point of view.	X		
In order to reduce the risk of fire, dirt, leaves and surplus lubricant, etc must be cleaned from the muffler, exhaust pipe and engine.	X		
Check that the stop switch works correctly.	X		
Check that the blades do not move when the engine is idling.	X		
Check that the blades are undamaged and show no signs of cracking or other damage. Replace the blades if necessary.	X		
Check that the blade guard is not damaged or distorted. Replace the blade if the blade guard is bent or damaged.	X		
Replace the cutting unit if it is bent or damaged.	X		
Check that the hand guard is not damaged. Replace the guard if damaged.	X		
Check that nuts and screws are tight.	X		
Check that there are no fuel leaks from the engine, tank or fuel lines.	X		
Clean the air filter and oil it in. Clean more often if conditions are exceptionally dusty.	(25 tim).		
Check the starter and starter cord.		X	
Check that the vibration damping elements are not damaged.		X	
Clean the outside of the spark plug. Remove it and check the electrode gap. Adjust the gap to 0.5 mm or replace the spark plug. Check that the spark plug is fitted with a suppressor.		X	
Clean the machine's cooling system.		X	
Clean the outside of the carburettor and the space around it.		X	
Fill the gear housing with grease. This should be carried out approximately every 25 working hours.		X	
Check that the screws that hold the blades together are correctly tightened.		X	
Check and clean the spark arrestor mesh on the muffler (only applies to mufflers fitted with a catalytic converter).		X	
Clean the inside of the fuel tank.			X
Check the inside of the fuel filter for any dirt or if the fuel hose has any cracks or other defects. Replace if necessary.			X
Check all cables and connections.			X
Check the clutch, clutch springs and the clutch drum for wear. Replace if necessary by an authorized service workshop.			X
Replace the spark plug. Check that the spark plug is fitted with a suppressor.			X

---

# TECHNICAL DATA

---

## Technical data

Technical data	SUPERLITE 4528	ERGOLITE 6028
<b>Engine</b>		
Cylinder displacement, cm <sup>3</sup>	21,7	21,7
Cylinder bore, mm	32	32
Stroke, mm	27	27
Idle speed, rpm	2800	2800
Recommended max. speed, rpm	9000	9000
Max. engine output, acc. to ISO 8893, kW/ rpm	0,6/7800	0,6/7800
Catalytic converter muffler	Yes	Yes
Speed-regulated ignition system	Yes	Yes
<b>Ignition system</b>		
Spark plug	NGK CMR6A	NGK CMR6A
Electrode gap, mm	0,5	0,5
<b>Fuel and lubrication system</b>		
Fuel tank capacity, litre	0,3	0,3
<b>Weight</b>		
Weight without fuel, kg	4,8	5,0
<b>Noise emissions</b>		
(see note 1)		
Sound power level, measured dB(A)	100	100
Sound power level, guaranteed L <sub>WA</sub> dB(A)	101	101
<b>Sound levels</b>		
(see note 2)		
Equivalent sound pressure level at the operator's ear, measured according to EN ISO 10517, dB(A):	93	93
<b>Vibration levels</b>		
(see note 3)		
Equivalent vibration levels (a <sub>h<sub>v</sub>,eq</sub> ) at handles, measured according to EN ISO 10517, m/s <sup>2</sup>		
Front/rear handles:	3,5/4,4	4,1/4,2
<b>Blades</b>		
Type	Double sided	Double sided
Length, mm	450	590
Blade speed, cuts/min	4050	4050

Note 1: Noise emissions in the environment measured as sound power (L<sub>WA</sub>) in conformity with EC directive 2000/14/EC. Reported sound power level for the machine has been measured with the original cutting attachment that gives the highest level. The difference between guaranteed and measured sound power is that the guaranteed sound power also includes dispersion in the measurement result and the variations between different machines of the same model according to Directive 2000/14/EC.

Note 2: Reported data for equivalent sound pressure level for the machine has a typical statistical dispersion (standard deviation) of 1 dB (A).

Note 3: Reported data for equivalent vibration level has a typical statistical dispersion (standard deviation) of 1 m/s<sup>2</sup>.

---

## TECHNICAL DATA

---

### EC-declaration of conformity (Applies to Europe only)

Husqvarna AB, SE-561 82 Huskvarna, Sweden, tel: +46-36-146500, declare under sole responsibility that the hedge trimmers **McCULLOCH SUPERLITE 4528, ERGOLITE 6028** from 2011's serial numbers and onwards (the year is clearly stated in plain text on the type plate with subsequent serial number), are in conformity with the standards or other normative documents following the provisions in the COUNCIL'S DIRECTIVES:

- of May 17, 2006 "relating to machinery" **2006/42/EC**
- of December 15, 2004 "relating to electromagnetic compatibility" **2004/108/EC**.
- of May 8, 2000 "relating to the noise emissions in the environment" **2000/14/EC**. Conformity assessment according to Annex V.

For information relating to noise emissions, see the chapter Technical data. The following standards have been applied:  
**EN ISO 12100-2:2009, CISPR 12:2007, EN ISO 10517:2009**

SMP Svensk Maskinprovning AB, Fyrisborgsgatan 3, SE-754 50 Uppsala, Sweden, has performed voluntary type examination on behalf of Husqvarna AB. The certificates are numbered:

**SEC/11/2327, 01/094/017** - SUPERLITE 4528, ERGOLITE 6028

Huskvarna 13 October 2011



Bengt Frögélius, Development manager (Authorized representative for Husqvarna AB and responsible for technical documentation.)

**WWW.McCULLOCH.BIZ**

Original instructions  
Bruksanvisning i original  
Originale instruktioner  
Originale instruksjoner  
Alkuperäiset ohjeet  
Originalanweisungen  
Instructions d'origine  
Originele instructies  
Instrucciones originales  
Instruções originais  
Istruzioni originali  
Originaaljuhend

Instrukcijas oriģinālvalodā  
Originalios instrukcijos  
Původní pokyny  
Pôvodné pokyny  
Eredeti útmutatás  
Instrukcja oryginalna  
Originalne upute  
Оригинальные инструкции  
Оригинални инструкции  
Instruções iniciais  
Αρχικές οδηγίες

1153995-38

